

Air Ejector Analysis in Normal and Abnormal Modes, Oriented to Control Purposes in Aircraft Systems

SCHILLACI Eugenio¹, OLIET Carles^{1}*

¹ *Universitat Politècnica de Catalunya-BarcelonaTech (UPC)
Heat and Mass Transfer Technological Center (CTTC)
C/ Colom, 11, Terrassa, E-08222, Spain
eugenio.schillaci@upc.edu, *carles.oliet@upc.edu*

VEMULA Jagadish Babu², DUPONCHEEL Matthieu², BARTOSIEWICZ Yann²

² *Université catholique de Louvain (UCLouvain)
Institute of Mechanics, Materials, and Civil engineering (iMMC)
B-1348, Louvain-la-Neuve, Belgium
jagadish.vemula@uclouvain.be, matthieu.duponcheel@uclouvain.be, yann.bartosiewicz@uclouvain.be*

PLANQUART Philippe³

³ *von Karman Institute for Fluid Dynamics (VKI)
EA department
Waterloosesteenweg, 72 - B - 1640 Sint-Genesius-Rode
philippe.planquart@vki.ac.be*

Abstract

The integration of Ultra High Bypass Ratio (UHBR) engines introduces important restrictions of space for the aircraft pylon, and as a consequence on the embedded bleed air system. Under this scenario, a reduction of the size of pre-coolers is demanded, and the selected option by Clean Sky 2 program is to achieve this goal by the introduction of air-air ejectors. Therefore, the current research is mainly aimed at gaining knowledge on supersonic ejectors for aeronautical applications, and to reproduce their behaviour by means of simplified models. For this purpose, a combined methodology based on experimental and CFD analyses is proposed to obtain physical insights and validation material for the development of a robust and accurate lumped model, capable of simulating the dynamic ejector behaviour in normal and abnormal conditions. In this paper, an overview on the performed activities is provided.

1. Introduction

Ejectors or jet pumps are passive flow devices with two inlets and one discharge port, which allow a secondary low-pressure stream to be entrained and compressed by a primary high-pressure one. The streams are mixed within the ejector and discharged at an intermediate backpressure. Ejectors have a pumping effect where the vacuum needed to create the suction is generated through the acceleration of the primary flow which occurs in the converging-diverging primary nozzle. In supersonic air-air ejectors, the secondary (induced) flow accelerates, potentially to above the sonic velocity in some conditions, and after its mixing with the primary stream, the flow is decelerated to favour pressure recovery from kinetic energy, reaching the final pressure.

The implementation of ejectors is getting an increasing interest in many industrial sectors, in order to improve the efficiency and reliability of several systems, especially in HVAC field [1]. The aircraft sector is also integrating ejectors for bleed air management, recirculation or ram-air ventilation. In the new generation of aircraft based on Ultra High Bypass Ratio (UHBR) engines, new bleed concepts are analysed to improve the overall efficiency of the system and to improve the integration with the wing. An option under analysis consists of employing a jet pump which uses the engine bleed air as a primary motive stream to entrain and mix a considerable quantity of air from the outside or from a lower pressure port as a secondary stream. By comparison to classic bleed systems, this leads to a reduction in the size of the pre-cooler, due to the significantly lower temperature of the air mixture. Moreover, reducing the amount of high-pressure bleed air extracted from the engine leads to a lower power percentage loss for non-propulsive tasks, with the consequent environmental and economic benefits due to the reduction of fuel consumption.

The physics and the modelling of ejectors in normal mode have been extensively tackled in the past, and the several simplified models available in the literature constitute a mature development e.g. Chen et al. [2] or Metsue et al. [3]. These models have demonstrated a good accuracy under low computational times, thus being useful for control purposes. However, to achieve a robust and general system level modelling, there is the need for 0D/1D models suitable to tackle abnormal functioning modes (including reverse flow occurrence at any inlet/outlet port of the ejector), and transient operation during transition between different modes of operation.

In this sense, the current research done by the authors is focusing on the understanding of the air ejectors under a broader operation perimeter than what can be found in the literature, through an operating map covering all modes of interest for aircraft systems. Computational Fluid Dynamics (CFD) simulations and experiments are being performed, to confirm the expected behaviour under normal operation, and to extend the knowledge to abnormal operations. All this understanding will be synthesized in new simplified models that will be implemented in a Modelica ejector object, for its integration in the whole system simulations. The final objective will be to use the tool for design and control purposes at the system level. The investigation is performed under the CleanSky2 project EJEMOD [4].

This paper presents the current status of simulations, experiments and Modelica model developments concerning the ejector working in different steady modes (normal and abnormal). The paper is organized as follows: in Section 2, the research structure is presented in detail. Next, the experimental set-up employed for the model validation is highlighted in Section 3. In Section 4, the CFD model employed to obtain further insights into the ejector physics is presented. The 0D model developed for the final tool implementation is detailed in Section 5. In Section 6, some of the obtained results are compared, explaining the underlying validation/tuning processes for the 0D model. Finally, conclusions are drawn in Section 7.

2. Research scope and methodology

The main objectives of this research work consist in acquiring knowledge about the proposed ejector geometries physics, both in their steady (on and off-design modes) and transient behaviours (transition between operating points by a change of boundary conditions). The wide working range analysed and the focus on the transitional phases will serve to acquire knowledge and transfer into accurate libraries applicable to the modelling of ejectors devices. The EJEMOD [4] project includes the three main following actions:

- Build the test bench and manufacture the ejectors previously defined. Perform the experimental testing of the ejectors to obtain physical insights, and to produce validation material for the numerical models.
- Perform CFD analyses of the proposed ejectors, studying all the operational regimes that cover the flight envelope conditions.
- Development and validation of 0D-1D numerical models on the Dymola platform for the dynamic simulation of ejectors covering all the modes, including Normal modes (Critical, Sub-critical, subsonic) and Abnormal modes.

In the first part of the project, summarized in this paper, the focus is given on the static behaviour of the ejector.

Operational envelope. For a given set of primary and secondary pressures, the operational modes of an ejector can be classified as function of the discharge pressure. For a back-pressure lower than a critical value, the ejector works in on-design mode and the entrainment ratio is constant and at its maximum. Both primary and secondary flows are choked (**double-choked condition**). In the off-design mode the entrainment ratio is between the critical entrainment ratio and zero. The secondary flow is sub-sonic, while the primary flow can be either choked (**single-choked condition**), or un-choked (**sub-sonic condition**). Finally, in the abnormal (back-flow) mode the entrainment ratio is less than or equal to zero. One of the project objectives consists in modelling the thermodynamic static and dynamic behaviour of proposed ejectors in their entire operating envelope. Operating phases, including normal and abnormal ones, can be listed as follows:

- Phase a: non-zero primary flow, non-zero secondary flow and non-zero flow at the jet pump outlet.
- Phase b: non-zero primary flow, zero secondary flow and non-zero flow at the jet pump outlet.
- Phase c: zero primary flow, non-zero secondary flow and non-zero flow at the jet pump outlet.
- Phase d: high pressure available in secondary but zero flow at the jet pump outlet (only possible during transitions).
- Phase e: high pressure available in primary but zero flow at the jet pump outlet (only possible during transitions).

Furthermore, different kind of reverse operational modes may appear during transitions or steady state operations, and need to be modelled to obtain a comprehensive understanding of the ejector behaviour for controlling purposes. The principal reverse modes are depicted in Figure 2.

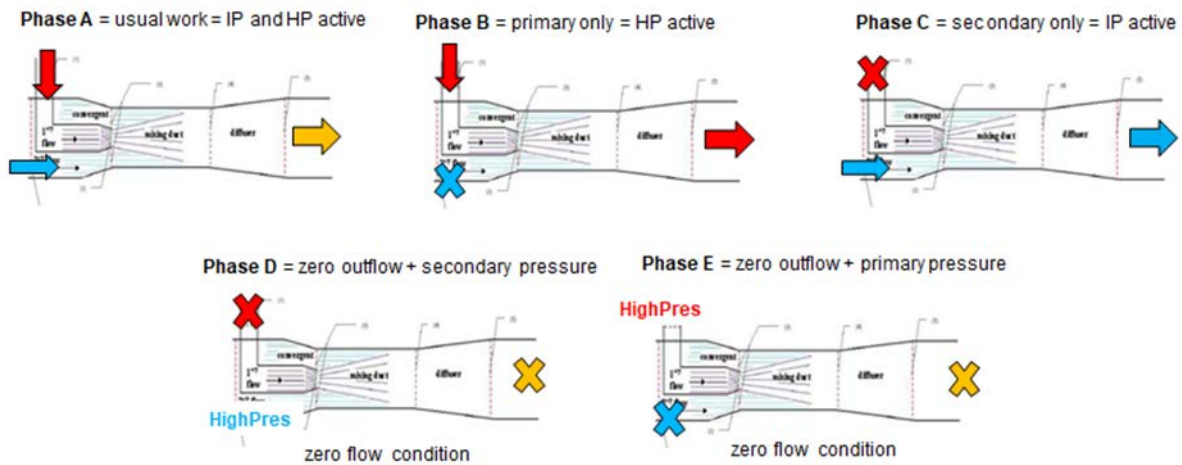

Figure 1: Phases/modes during ejector operation.



Figure 2: Reverse flow modes during ejector operation.

3. Experimental set-up

To acquire the experimental data needed to cover the first part of the project, and to test the different ejectors proposed, an experimental test bench was designed and built by VKI. The first test bench is developed to carry out tests in static conditions by setting primary and secondary pressures and temperatures as well as back-pressure. In the second part of the project the set-up will be extended to study the dynamic behaviour of the ejector. The characterisation of ejectors using atmospheric conditions in the secondary flow can be done by performing mass flow measurements of the primary and secondary flow, pressure measurements and temperature measurements at the inlet of the primary flow and at the outlet of the ejector. For pressurized secondary flows, pressure and temperature of the secondary flow are controlled as well. The sketch of the test bench for static measurements is represented in Figure 3, while some pictures of the global set-up are reported in Figure 4.

Ejectors. The ejectors housing and piping are built at VKI. It was initially foreseen to build the complete ejectors within VKI workshop but finally the elbow of the primary nozzle has been 3D-printed by an external company. One of the ejectors manufactured for the current research is shown in Figure 5. It has interchangeable cones to test different primary nozzle diameters.

Connections and valves. Compressed air at ambient temperature enters the building from an external tank. The flow is then divided in two pipes (one for the primary line and one for the secondary line). Each pipe has first a 90° turn valve to be able to isolate completely the line. It is followed by a pressure regulator that can be remotely controlled with a pressure regulation from 1 bar to 8 bars. This pressure regulator will be used to limit the pressure inside the different lines. After the pressure regulators, a regulation valve is placed to adjust the flow rate inside each line. Two flexible tubes (stainless steel tube resisting to high temperature and high pressure) are afterwards leading the flow to the entrance of the primary or secondary lines. These flexible tubes give the option to feed with heated air either the primary or the secondary line (depending on the test matrix). Finally, a valve for pressure regulation at the outlet of the final vertical straight tube will allow us to control the back pressure.

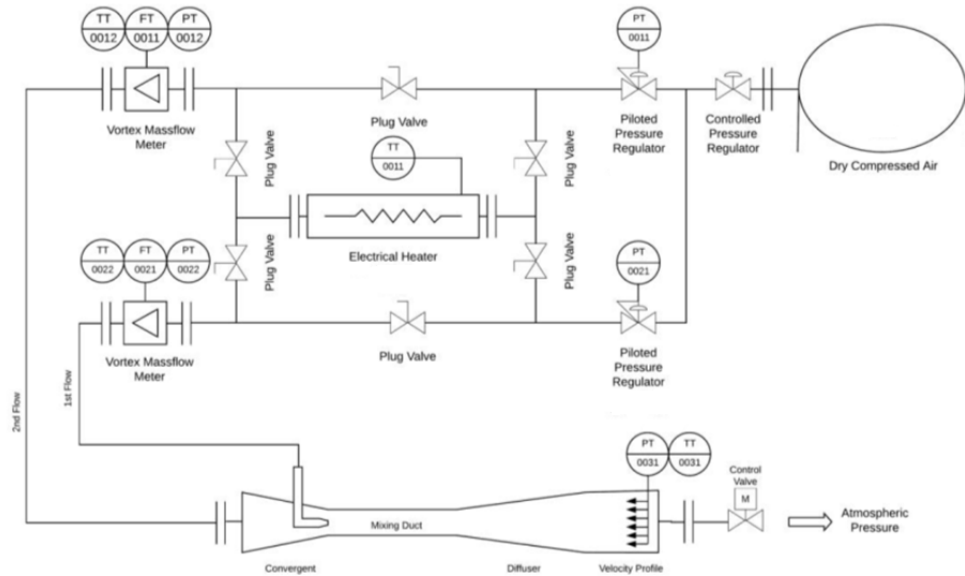

Figure 3: Test bench for ejector static analysis.



Figure 4: Left: instrumented ejector in the experimental set-up. Right: electrical heater.

Electrical Heater. An electrical heater is used to investigate temperature effects. It can be connected to either primary and secondary lines, thus heating only one of them at a time. The heater consists of two elements of 75 kW providing a maximum heating power of 150 kW. The heating power allows to reach the maximum temperature required with the specified maximum mass flow rate. The heater has a maximum operating pressure of 8 bars.

Mass flow meters. The mass flow of each line is measured with a vortex mass flow meter. Three different mass flow meters (DVH-P model vortex flow meter from Kobold: www.kobold.com) have been acquired for the project to cover the required range of mass flows. These multivariable meters can provide mass flow, temperature, pressure and density readings. The mass flow meters can work with high temperature gas and have an accuracy of 1% for the volumetric flow rate (1.5 % for the mass flow rate).

Thermocouples. Four thermocouples (type K – assembled at VKI) are positioned at each measurement locations with four different radial position to capture temperature profiles inside the different lines.

Pressure sensors. Pressure measurements are performed with Validyne pressure sensors (www.validyne.com) connected with flexible tubes to the pressure measurements.. The DP15 variable pressure sensor with a replaceable pressure sensing diaphragm has been selected. The choice of the diaphragm according to the pressure range allows performing measurements with high accuracy. This differential pressure sensor provides a fast response thanks to a small pressure cavity volume. For the dynamic analysis, Kulite fast response pressure sensors will be installed to capture the transient pressure field.



Figure 5. Primary nozzle with the nominal cone and the three different adaptive cones.

4. CFD analysis

CFD simulations are aimed at analysing all modes of operation, including detailed maps of pressure, Mach number and streamlines within the ejector. These maps allow an efficient formulation of the OD models introduced in the next section.

Numerical set-up. A schematic view of the 2D-axisymmetric domain reduced from 3D geometry is shown in Figure 6(a), with the computational domain coinciding with the shaded region. The primary nozzle reaches sonic flow conditions at the exit of the converging nozzle (Figure 6(b)).

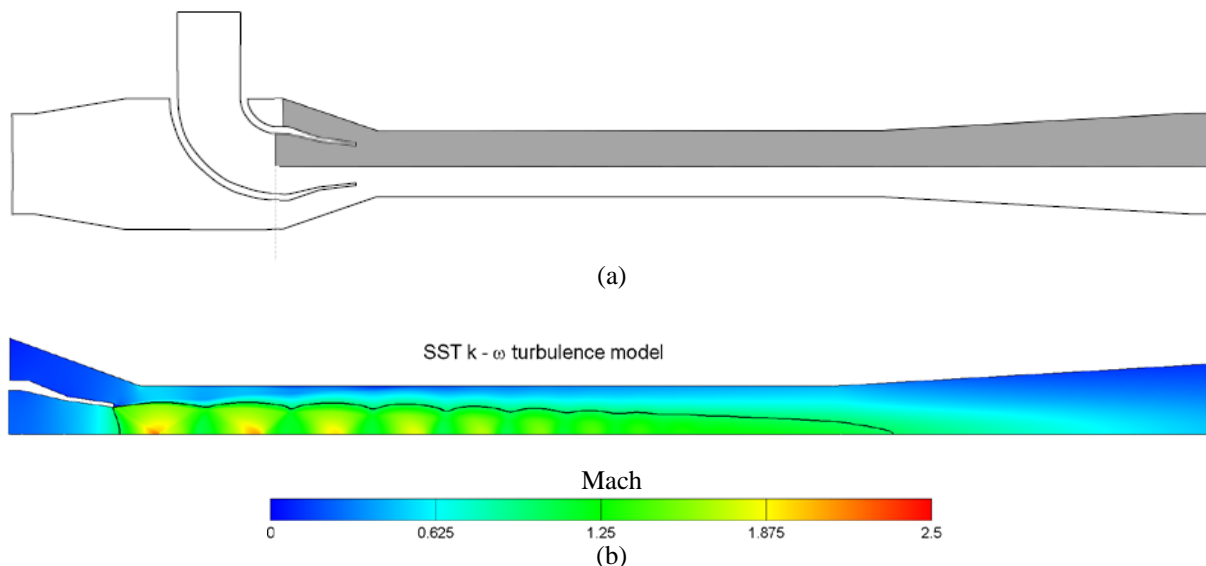

Figure 6: Ejector CFD analysis. (a) The shaded region of the G3-N1 ejector is the considered computational domain for 2D-axisymmetric simulations. (b) Mach number within the ejector.

The commercial CFD package Fluent is used to model the flow within the ejector, and the structured mesh is generated using the Ansys meshing tool. The steady-state converged flow is achieved in the numerical simulations by using the coupled solver with an ideal gas law assumption. Regarding the boundary conditions, a total pressure is imposed at the primary nozzle and secondary nozzle's inlet sections and the static pressure at the outlet section of the

ejector. For numerical simulations with the valves closed, the inlet and outlet are replaced by a wall boundary condition in the corresponding port. No-slip conditions for the velocity and adiabatic boundary conditions are specified on the surface.

In a first step, the sensitivity of the simulations to different numerical parameters was investigated to define the numerical setup that will be used for the project. Boundary conditions employed for the initial model verification and validation are taken from the flight envelope conditions. The set-up of an effective and reliable computational approach was possible by applying the knowledge acquired in past reference works in the field, like Mazzelli et al. [5] or Lamberts et al. [6]. Model validation is performed by:

- Comparison of numerical outputs with theoretical results, mainly in terms of mass flow rates obtained from isentropic relations.
- Quantifying the effect of turbulence models and turbulence intensity on the performance of the ejector. The flow turbulence is modelled using the $k - \omega$ based models, in which the SST model is well suited to predict supersonic flow with mixing and shock waves in ejectors. A screenshot of the Mach number within the ejector simulated domain is reported in Figure 6(b), showing different shock cells and a whole shock train inside the mixing zone. The employed turbulence model was the one providing best results in terms of shock lengths by comparison to reference results [5].
- A detailed grid convergence analysis, explained in detail in the following paragraph.

Grid convergence analysis. The grid convergence study is done for three mesh sizes: coarse, medium, and fine mesh. The initial mesh (coarse) domain comprises about 285970 quadrilateral elements, and the cells close to the primary nozzle and walls are small enough to capture the complex flow phenomenon. In order to better predict the internal flow, mesh refinement is employed. The medium-mesh domain comprises about 547892 quadrilateral elements, as more cells are added at locations with significant flow changes. The fine mesh accounts for 641485 quadrilateral elements, thus, enabling the flow field features to be better resolved. Grid is also refined in the near-wall regions to capture the boundary layer and the region between the primary nozzle exit and entry of the mixing chamber to capture the pseudo shock train with exponential stretching in the X-direction and Y-direction. The mesh refinement in the vertical direction ensures that the centre of the cell adjacent to the wall is always at $y^+ < 1.55$ (for all meshes). For all the numerical results, the origin is fixed on the ejector centreline (symmetry axis), placed at the entry of the mixing duct. Mach number variation and pressure distribution along the centreline of the ejector are shown in Figure 7 and are used to identify a grid converged solution. The results obtained on the fine mesh are sufficient to get grid converged solution for given conditions. Here, the computational time increment for the simulation with fine mesh is very minimal compared to the medium mesh. Therefore, the fine mesh is used for all the simulations.

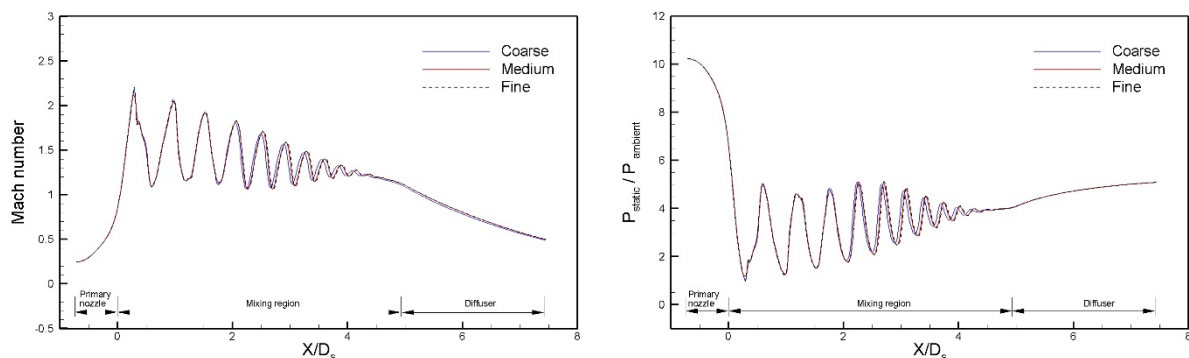

Figure 7: Mach (left) and pressure (right) distribution along ejector axis for different mesh sizes. Medium and fine grid are converged. Length of the ejector is non-dimensionalised by secondary nozzle inlet diameter, D_s .

5. 0D Modelling

Background. In traditional ejector models mass flows are estimated by starting from inlet and outlet pressures (and temperatures). Calculation starts by calculating mass flow rate in double choked conditions. Those ejector models are capable of representing the ejector behaviour only in double-choked (on-design), or single-choked (off-design) conditions. For this reason, they are called supersonic ejector models. In Chen et al. [2] the Fabri-Choking theory

applies: a hypothetical throat is formed by the primary flow and the ejector wall, and that the secondary stream reaches the sonic velocity at that particular location. The more modern Compound-choking theory is employed in recent works, like Metsue et al. [3]: the compound choking criterion takes into account the state of both streams at the same location. The combined flow can be compound-choked even though the Mach number of one stream is less than one provided the Mach number of the other stream is sufficiently larger than one.

However, air ejectors do not always work in supersonic conditions, as it is possible to find some operating conditions in which the flow remains in subsonic conditions throughout the expansion process. In the literature, a couple of works have been identified which perform calculation of convergent sub-sonic ejectors. In those works, different assumptions are made to calculate the pressure at the throat of the ejector. In Besagni et al. [7], the pressure is evaluated by employing CFD to evaluate Mach number at the throat. On the other side, in Zhu et al. [8] the pressure at the throat is considered as equal to the secondary pressure (simplification with limited field of validity) and the secondary mass flow follows geometrical consideration for its evaluation. These methods are not directly applicable, as they depend on CFD data or are based on assumptions with a limited range of applicability.

Multi-modal approach. In general, the listed 0D models are valid only for normal operation modes, and are not easily extensible to abnormal modes, e.g. when one of the ports is closed or one flow goes in reverse direction. One of the objectives consists in building a reliable and robust 0D model capable of covering the ejector operation in the following operating modes:

- Normal mode
- Secondary closed (direct or reverse)
- Primary closed (direct or reverse)
- Back closed (direct or reverse)
- Reverse flow - secondary reversed
- Reverse flow – primary reversed

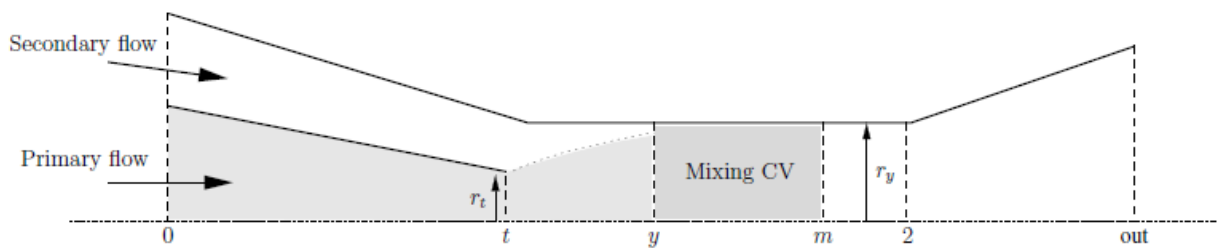

Figure 8. Supersonic ejector scheme employed for the 0D modeling.

Resolution algorithm. The domain of the 0D model is reported in Figure 8, where t indicates the primary nozzle throat, y marks the ends of the expansion zone for primary and secondary flows and the beginning of the mixing, m indicates the end of the mixing region. When it exists, the normal shock is placed between section m and 2. The final expansion occurs in the diffuser zone between 2 and *out*. Boundary conditions are the total pressure and temperature at the primary and secondary ports, p_{p0} , T_{p0} , p_{s0} , T_{s0} , respectively, and the static pressure at the outlet, p_{out} . Moreover, the model depends on some of the geometrical features of the ejector, namely, diameter at the throat d_t and at the mixing section, d_y , and on the isentropic efficiency, primary, η_p , secondary, η_s , and mixing, η_m , respectively.

Inlet conditions for the ejector can also be expressed in terms of inlet pressure ratio, $R = p_{s0}/p_{p0}$. Main outlet quantities of interest are mass flow rates, m_p and m_s , as well as the entrainment ratio, $\omega = m_s/m_p$.

The preliminary step (Step 0) consists in calculating the maximum possible primary and secondary mass flow rates, according to the flow maximization criterion proposed by Metsue et al. [3]. An initial pressure p_y is guessed, close to the higher inlet pressure.

Hence, the main steps of the iterative algorithm are reported below:

- Step 1: Calculation of primary mass flows as function of pressure p_y . If the flow is supersonic, two different pressures at the throat and at y are calculated. In the case of sub-sonic flow in the primary nozzle, the expansion ends at t , the sections t and y are coincident.
- Step 2. The secondary flow is calculated, as a function of the guessed pressure at the y section. If the secondary port is closed, this step is omitted.
- Step 3. Application of conservation equations in the mixing section to evaluate temperature and velocity of the mixture.

- Step 4. Check of the Mach number after the mixing. If the flow is still supersonic, application of thermodynamic relations for Normal shock at the end of the mixing section to recover pressure.
- Step 5. Static pressure recovery in the diffuser.
- If the calculated value for the outlet pressure p^*_{out} is higher than the backpressure, p_y is decreased iteratively to find the effective mixing pressure that leads to $p^*_{out} = p_{out}$.

Perfect gas formulation is employed to reduce computational times and to get rid of external libraries that would be needed if employing real gas properties.

6. Validation and Results

A big amount of data has been obtained during the experimental and CFD numerical campaigns of the project. Those data are aimed at performing direct measurement and obtain physical insights into the behaviour of the ejectors analysed. Moreover, the data were needed to identify the best lumped models to represent the ejector behaviour as well as their validity ranges. An important task was the identification of the necessary number of modes to cover the whole envelope. Moreover, the observation of detailed CFD results led to the formulation of new models to cover the modes that could not be covered effectively by models available in the literature. In the next paragraphs, some of the data obtained and the procedures followed to validate/calibrate the 0D models are explained.

6.1 Comparison to experimental data

Normal modes. In the first experimental tests aimed at validating the 0D model in a normal mode of operation, characteristic curves of the ejector for two pressure ratios were reproduced. Details regarding boundary conditions are reported in Table 1. An ejector characteristic curve is obtained by keeping a constant ratio of secondary to primary nozzle pressures while varying the backpressure.

The 0D model is effectively able to reproduce this behaviour, as shown in the Figure 9(a) where the mass flow rate of the primary is reported. The primary mass flow rate is constant and corresponds to its maximum value, meaning that the ejector is always at least single-choked in this operating range. The mass flow rate of the secondary, shown in Figure 9(b), never reaches a plateau, and its value is decreasing. This means that the secondary flow is never critical and that therefore the ejector is globally in single-choked conditions. The agreement between experimental results and 0D is good, as also confirmed by the entrainment ratio plot, Figure 9(c). A certain deviation is seen when m_s is approaching to 0. This is due to the lack of enforcement of mass conservation in the current version of the model, for the purpose of maximizing the robustness and its simplicity.

Abnormal mode. In Figure 9(d) the primary mass flow rate evaluated for the abnormal case of closed secondary port (Phase b) is reported and compared to 0D model results, for two different inlet pressures. Operating conditions are reported in Table 1 (in non-dimensional form for confidentiality issues). The characteristic curve shows how the mass flow rate is initially constant at its maximum value (choked-condition), while it begins to decrease for higher values of the outlet pressure. In this case, the flow through the primary nozzle is therefore no longer critical, but enters a subsonic regime. Hence, the 0D model works with good accuracy, representing the ejector behaviour both in supersonic and subsonic conditions.

Table 1. Experimental cases

| | R | $p_{p0}/p_{p0,max}$ | Remarks |
|-----------------|-----------|---------------------|-----------------------|
| Case Normal 1 | 0.53±0.02 | 0.36 | - |
| Case Normal 2 | 0.4±0.42 | 0.47 | - |
| Case Abnormal 1 | - | 1.04-1.19 | Secondary port closed |
| Case Abnormal 2 | - | 0.7-0.78 | Secondary port closed |

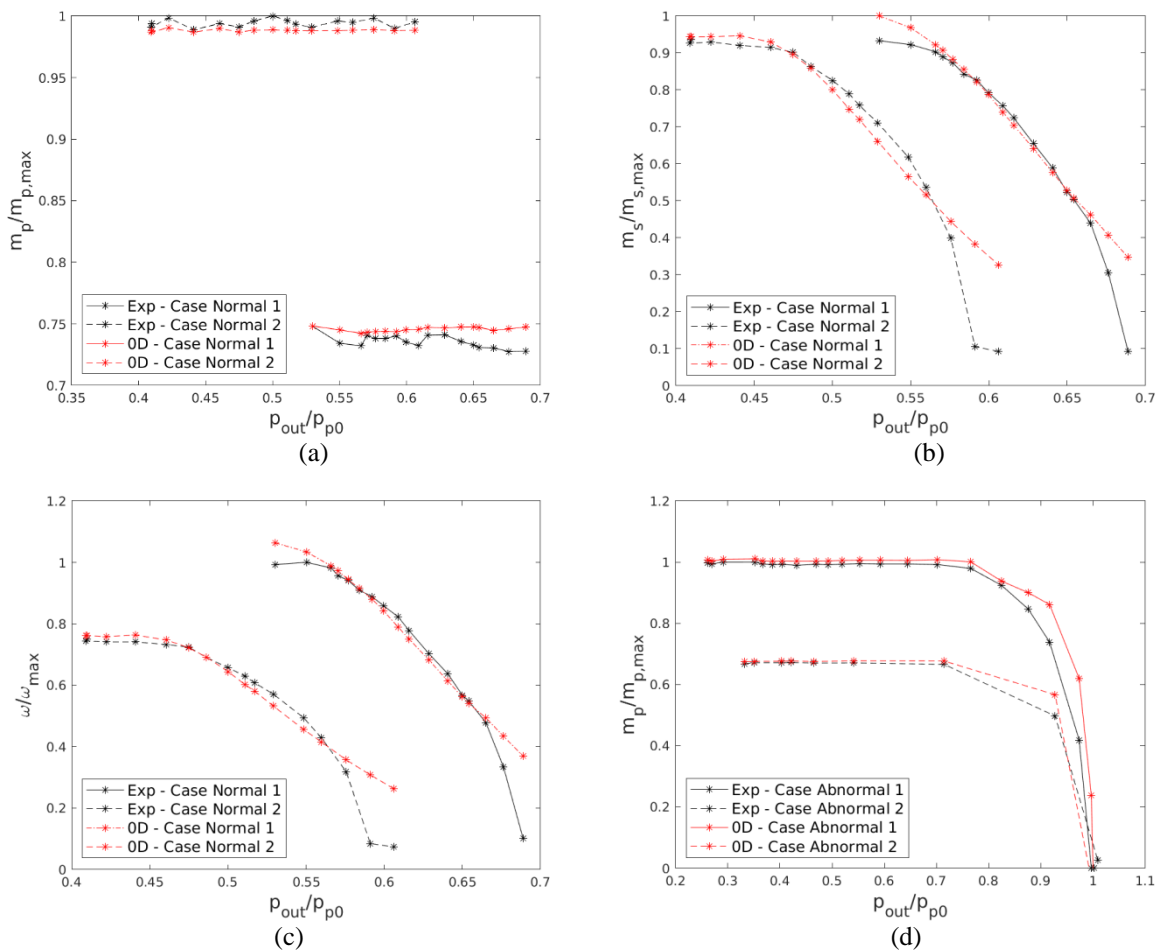

Figure 9. Experimental results obtained in normal and abnormal modes, and comparison with results obtained from the 0D model.

6.2 Comparison with CFD results and extensions of the 0D model

The use of CFD results has been a key factor in formulating 0D models that can accurately describe the behaviour of the ejector, by providing detailed pressure and Mach number maps or streamlines. This is particularly important when you want to cover unconventional modes of operation, as in the case of abnormal modes, or when you want to optimize simple models in areas at the limit of their validity range. Below it is explained how the contribution of the CFD is important in the formulation of a model that is accurate on the entire operational envelope in Normal mode, and in the case in which a model must be built for an unconventional regime, whose behaviour has had scarce consideration in the literature, as in the abnormal case of the secondary port closed. Cases analysed in this section by means of the CFD and 0D models are summarized in Table 2.

Table 2. CFD Cases.

| | R | $p_{p0}/p_{p0,max}$ | Remarks |
|-----------------|----------------------------------|---------------------|-----------------------|
| Cases Normal | 0.2, 0.4, 0.58, 0.7, 0.8 and 0.9 | 1 | - |
| Case Abnormal 3 | - | 1 | Secondary port closed |

Normal mode. The 0D model described in this work is able to represent the ejector behaviour in critical, subcritical and sub-sonic conditions. However, above a certain value of R , the values of ω start to move away from the CFD value. This phenomenon can be explained by analysing the Mach and pressure distributions in the mixing zone obtained in the CFD simulations as function of R , as shown in Figure 10. It was possible to extract the following information:

- Up to $R=0.7$ the primary flow reaches $M=1$ at the primary nozzle throat. As the sonic section area is close to that of the throat the primary flow rate is very close to the maximum possible one. In these conditions, primary flow is entering the mixing zone in supersonic conditions, and compound/Fabri choking criteria apply.
- For $R=0.9$ the aerodynamic throat moves towards the end of the mixing zone. The two flows enter the mixing zone in subsonic conditions and acceleration and choking are due to Fanno Flow effects. The primary flow decreases its plateau, meaning that a significant change in the expansion process has been happening.
- For $R=1.0$ the aerodynamic throat coincides with the end of the mixing zone. This is the extreme case of *perfect-mixing* operation, where the two streams have approximately the same velocity when they meet at the end of the primary nozzle.

In our 0D model, we propose to model the delay in the mixing by modifying the primary efficiency after a critical limit of $R=R_{critical}$, to modify the shape of the primary expansion zone. In particular, η_p is kept constant (at its maximum value, $\eta_{p,max}$) until $R_{critical}$. Then, a linear variation (reduction) as function of R is set, until reaching a minimum value, $\eta_{p,min}$, for $R = 1$.

In the analysis proposed here, six different characteristic curves are obtained by varying the primary to secondary pressure ratio in order to compare with the CFD results. In particular, the following values for R are tested: 0.2, 0.4, 0.58, 0.7, 0.8 and 0.9. For each characteristic curve, the backpressure is varied to cover the on-design and off-design conditions. The proposed approach is able to provide a good match for the primary mass flow rate in the whole range of R values, as reported in Figure 11 (a). The primary mass flow rate assumes the maximum value for low values of R , since the efficiency of the primary is maximum for $R < 0.7$, as explained above. For higher R , the plateau of m_p lowers progressively, due to the reduction of the expansion efficiency. Moreover, the model can accurately compute the secondary mass flow rate, Figure 11 (b), and the entrainment ratio, Figure 11 (c), from very low to very high R .

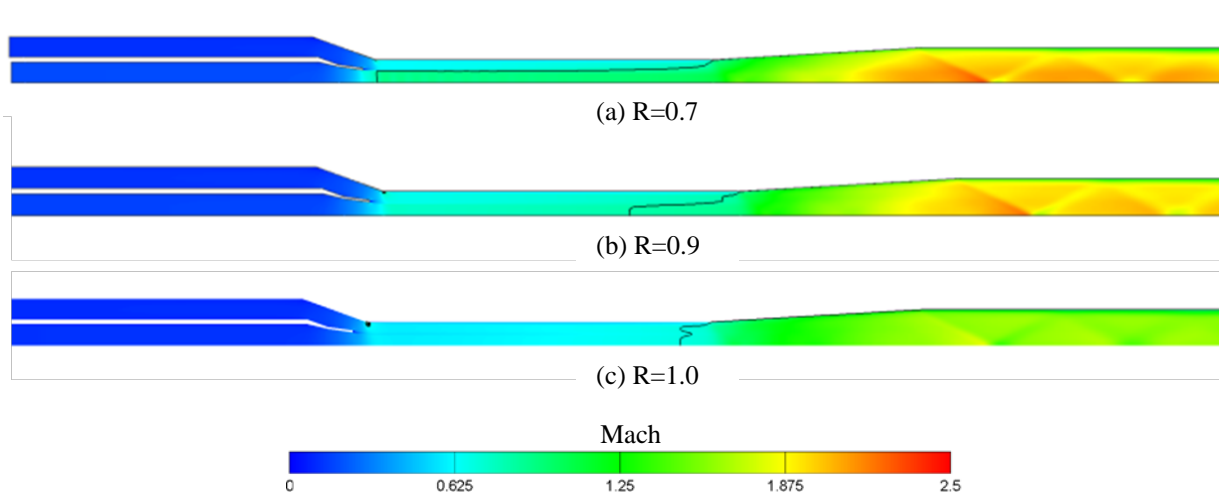

Figure 10. Mach number within the ejector extracted from CFD as function of R . The black line indicates $M=1$.

Abnormal mode. In Figure 11 (d), the primary mass flow rate for the ejector working with secondary port closed is reported, as function of the backpressure. The 0D model switches between two modes to model the whole operational envelope: the *Secondary-Closed* mode is employed when $p_{p0} > p_{out}$, while the *Secondary-Closed - Reverse Flow* mode is activated once the backpressure gets higher than the primary pressure. In the forward mode, the isentropic efficiency of the primary expansion is adjusted as a function of the backpressure, by means of a linear interpolation, in order to take into account the modification of the expansion process as the latter is increased. This effect was highlighted from CFD simulations as well, and the interpolation of the isentropic efficiency is aimed at fitting CFD results as well as possible. In reverse flow conditions $p_{out} > p_{p0}$, the ejector still behaves as a normal nozzle, but the flow enters from the back port and leaves the ejector from the primary nozzle. The physical throat is coincident with the primary nozzle throat (observed from Mach number maps obtained from CFD). Again, an adjustment of the efficiency is needed in order to fit CFD data. The value of the efficiency starts from a minimum

value and then increases progressively according to a linear relation, up to a maximum value reached after a critical pressure ratio.

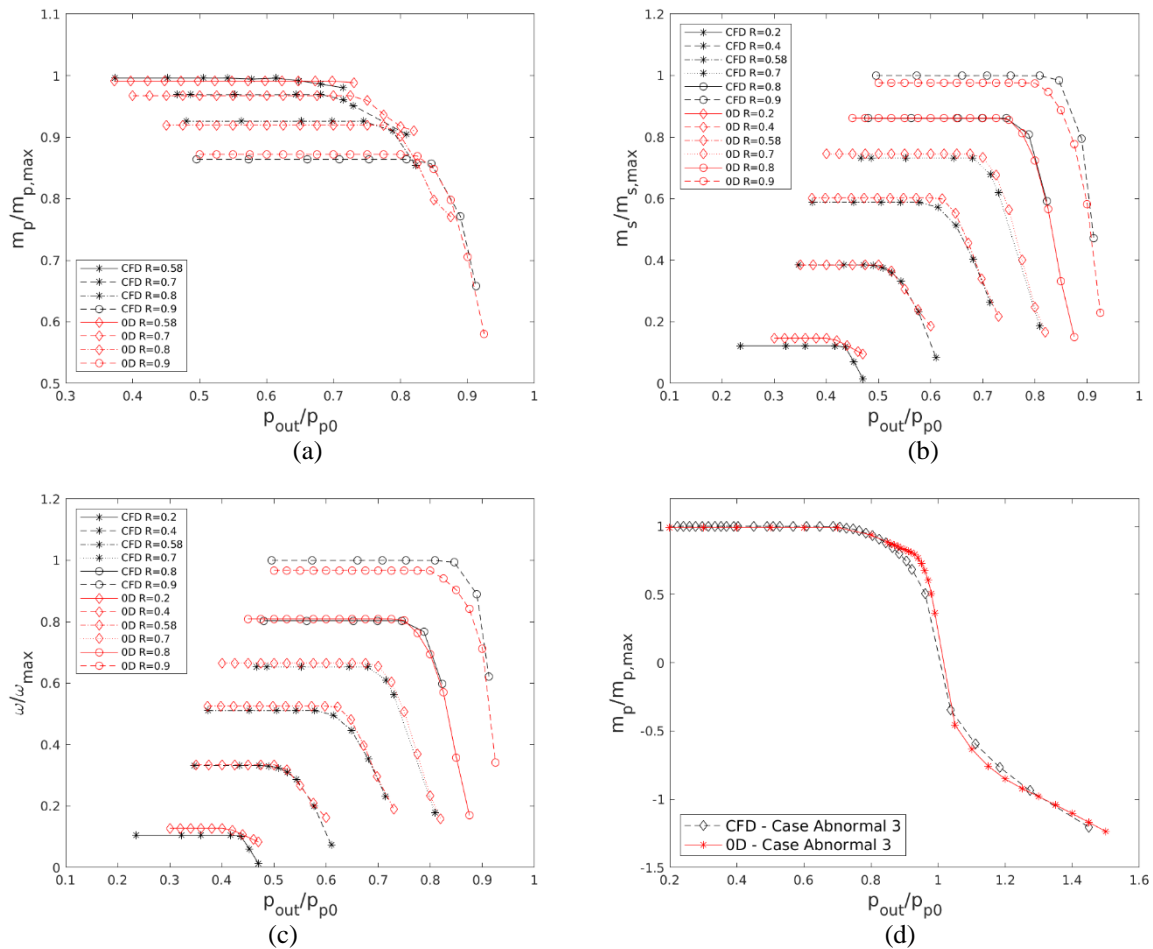

Figure 11. Ejector outputs obtained with CFD and comparison with 0D model results, both in normal (a,b,c) and abnormal modes (d). In (a) $m_p/m_{p,max}$ curves for R lower than 0.58 are not reported since they totally overlap.

7. Conclusions

In this paper, the current EJEMOD [4] research project within CleanSky 2 framework is presented in detail, explaining its general context and the various activities performed during its first part. Large experimental and CFD campaigns were already carried out to obtain several physical insights into the supersonic ejectors for aeronautical bleed system applications. Some of the results were designed and aimed at providing validation material for the development of an accurate and robust 0D model to model the ejector behaviour in transient scenarios.

As demonstrated by the fine agreement between experimental and numerical data representing both normal and abnormal modes, the extended multi-mode model is able to cover all the identified operational modes in a reasonable way. The normal operation modes include double-choked, single-choked, and sub-sonic conditions. On the other side, the abnormal modes analysed here are the cases in which the secondary port is closed, including both direct and reverse flow configurations.

In different situations, as in reverse flow conditions or when unusual situations occur, e.g. primary flow subsonic at the beginning of the mixing section, the adoption of calibrated efficiencies was needed to fit properly CFD data and to represent accurately the underlying physical processes. Relevant advancements have been performed by comparison to the state-of-the-art in ejector modelling for unconventional situations.

Acknowledgements

This project has received funding from the Clean Sky 2 Joint Undertaking (JU) under grant agreement No 101008100. The JU receives support from the European Union's Horizon 2020 research and innovation programme and the Clean Sky 2 JU members other than the Union.



Carles Oliet, as a Serra Húnter lecturer, acknowledges the Catalan Government for the support through this Programme.

Disclaimer: The contents presented in this article reflect only the author's point of view: the authors and Clean Sky JU are not responsible for any use that may be made of the information it contains.

References

- [1] G. Besagni, R. Mereu and F. Inzoli, "Ejector refrigeration: A comprehensive review," *Renewable and Sustainable Energy Reviews*, vol. 53, pp. 373-407, 2016.
- [2] W. Chen, M. Liu, D. Chong, J. Yan, A. Little and Y. Bartosiewicz, "A 1D model to predict ejector performance at critical and sub-critical operational regimes," *International journal of refrigeration*, vol. 36, no. 6, pp. 1750-1761, 2013.
- [3] A. Metsue, R. Debroeyer, S. Poncet and Y. Bartosiewicz, "An improved thermodynamic model for supersonic real-gas ejectors using the compound-choking theory," *Energy*, vol. 238, p. 121856, 2022.
- [4] Cordis. [Online]. Available: <https://cordis.europa.eu/project/id/101008100>.
- [5] F. Mazzelli, A. Little, S. Garimella and Y. Bartosiewicz, "Computational and experimental analysis of supersonic air ejector: Turbulence modeling and assessment of 3D effects," *International Journal of Heat and Fluid Flow*, vol. 56, pp. 305-316, 2015.
- [6] O. Lamberts, P. Chatelain, N. Bourgeois and Y. Bartosiewicz, "The compound-choking theory as an explanation of the entrainment limitation in supersonic ejectors," *Energy*, vol. 158, pp. 524-536, 2018.
- [7] G. Besagni, R. Mereu, P. Chiesa and F. Inzoli, "An Integrated Lumped Parameter-CFD approach for off-design ejector performance evaluation," *Energy Conversion and Management*, vol. 105, pp. 697-715, 2015.
- [8] Y. Zhu and Y. Li, "New theoretical model for convergent nozzle ejector in the proton exchange membrane fuel cell system," *Journal of Power Sources*, vol. 191, pp. 510-519, 2009.