

# Non-Linear Model Identification Analysis for a TVC Electro-Hydraulic Actuator

*Julia Guimaraes\* and Waldemar de Castro Leite Filho\*\**

*\*National Institute for Space Research*

*Av. Dos Astronautas, 1758 – Sao Jose dos Campos, SP – Brasil – julia.guimaraes@inpe.br*

*\*\*National Institute for Space Research*

*Av. Dos Astronautas, 1758 – Sao Jose dos Campos, SP – Brasil – waldclf@gmail.com*

## Abstract

When designing control systems, electrohydraulic actuators applied to thrust vector control can represent a great challenge due to their highly nonlinear dynamics. This work aims to study some of the issues encountered when modelling nonlinear effects of such actuators on the Brazilian satellite launcher VLS and how it is possible to overcome these issues using a frequency identification approach. Furthermore, it is shown how the use of transfer functions can eventually mask the influence of initial conditions on real systems. Finally, a complete nonlinear actuator model is presented and its results are compared to Hardware-In-The-Loop simulations.

## 1. Introduction

In the preliminary design phase of an engineering project, simplified linear models are often used to gain a greater understanding of the physical problem. This approach, however, may hide complex phenomena.

More specifically, hydraulic systems can represent a huge challenge in the development of control systems due to its highly nonlinear dynamics [1], even when most of the electrohydraulic actuators in the industry are controlled by linear controllers [6].

When developing the control algorithms for the Brazilian satellite launcher VLS, a linear model was used for the electrohydraulic actuator used to move the nozzle during the thrust vector control (TVC) [2]. Later, hardware in the loop (HWIL) simulations were used to understand how the nonlinearities in the actuator would affect the vehicle in flight, leading to the prediction of a limit cycle [8].

During flight, however, an unexpected aerodynamic phenomenon led to unpredicted forces on the nozzle, tripling the limit cycle amplitude and leading the vehicle's control system to become temporarily deficient.

Since then, the development of a more complete model, especially with respect to its reproduction of the actuator's limit cycle, was of interest to the Brazilian space program.

Previously, a strategy based on the use of describing functions was used to model the predicted nonlinearities using hardware in the loop results [7]. While the resulting model was able to reproduce some overall aspects of the limit cycle, such as amplitude, its shape was not representative of the real actuator output.

The authors wished to resume this work, but material constraints made it impossible to recreate the hardware in the loop installations used in the past for any online identification strategy. Therefore, an alternative technique had to be developed to extract new information on existing data.

As first described in [9], a model created using fast Fourier transform (FFT) analysis of the actuator output was able to reproduce most of the scenarios considered in the study. However, that model did not take into account the effect of initial conditions on the resulting limit cycle, nor does it consider the influence of the position of elements on the model itself.

This work aims to expand on the mathematical models and techniques used to empirically identify the nonlinear model of an electrohydraulic actuator without the possibility of online identification techniques or the use of rich signals.

## 2. Mathematical Model

The nonlinear model for the servo mechanism used in a movable nozzle for thrust vector control is presented in [11]. A simplified version of the model considered is reproduced in Figure 1.

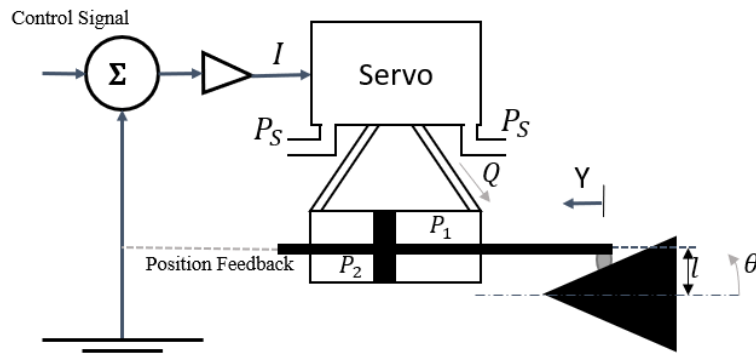

Figure 1: Electrohydraulic actuator for a movable nozzle.

The relationship between the input electric current  $I(s)$  and the cylinder displacement  $X(s)$  can be modelled by a second order equation.

$$X(s) = \frac{K_{sv}}{s^2 + as + b} I(s) \quad (1)$$

The cylinder displacement is related to the flow on the valve,  $Q_T$ , by a nonlinear equation [10], in which  $K_h$  is the hydraulic proportionality constant,  $P_s$  is the pressure on the source and  $P_L$  is the load pressure, defined as the difference between the pressures  $P_1$  and  $P_2$  shown in Figure 1.

$$Q_T(s) = K_h \sqrt{P_s - |P_L|} X(s) \quad (2)$$

The flow on the valve can also be related to the piston area  $A_{ef}$  and to the total volume of cylinder occupied by the fluid  $V_T$ , as well as the compressibility coefficient  $\beta$  by Equation (3), where  $y$  is the linear position of the nozzle.

$$Q_T(s) = A_{ef} \frac{dy}{dt} + \frac{V_T}{4\beta} \frac{\nabla P_L}{dt} \quad (3)$$

The angular position of the nozzle,  $\theta$ , is assumed proportional to  $y$ , as described by Equation (4).

$$\theta(s) = K_y Y(s) \quad (4)$$

Finally, the torque  $\tau$  on the nozzle can be modelled by Equation (5), considering elasticity ( $K_a$ ) and viscous friction ( $K_v$ ), as well as the inertia  $J$ . The torque is dependent on the area on the base of the piston,  $A$ , the lever  $l$  and the load pressure, as described by Equation (6).

$$\tau = J \frac{d\theta^2}{dt^2} + K_v \frac{d\theta}{dt} + K_a \theta \quad (5)$$

$$\tau = AlP_L \quad (6)$$

The equations presented here can be summarized on a block diagram, shown on Figure 2.

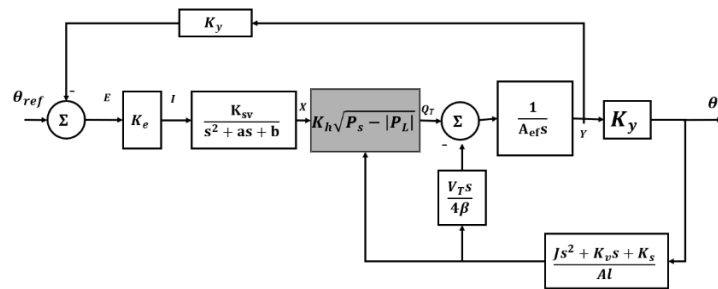

Figure 2: Block diagram for an electrohydraulic actuator model.

### 3. Initial Model

When first attempting to identify the actuator model, [2] used an approach based on input-output analysis, which is alternative to the direct use of mathematical models but that has proven useful with hydraulic systems [5].

Initially, open loop tests were used to study how the actuator would respond to step and sinusoidal inputs. Later, input free closed loop tests were used to recreate limit cycle conditions.

The limit cycle identification strategy consisted of connecting the actuator to a simulator running a simplified model of the vehicle dynamics under a PD controller and obtaining the resulting limit cycle by using a null reference. The use of different parameters on the simplified dynamical model ( $\mu_b$ ) and different control gains would lead to different inputs for the actuator and, therefore, to different outputs that could be used to identify the system.

Figure 3 shows the final model configuration proposed by [2], where the linear part of the system was represented by a transfer function, a separate integral block and a transport delay, while the nonlinearities were a dead zone on the forward path and a backlash on the feedback path.

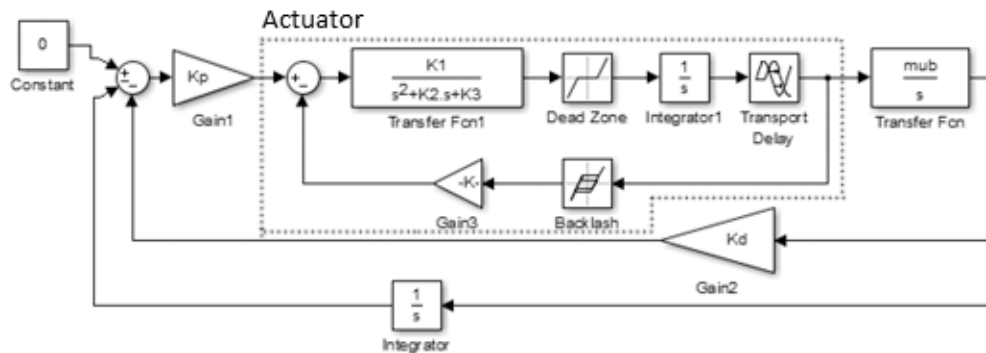

Figure 3. Hardware in the loop identification scheme.

While this configuration was chosen because the analysis can be easily transposed to describing function models, as show on Figure 4, this approach leads to relatively poor input signals on the actuator.

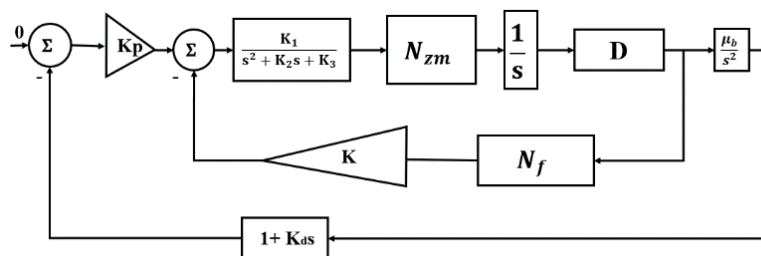

Figure 4. Hardware in the loop identification scheme, in which the nonlinearities are modelled as describing functions.

#### 4. Model Identification

Since the authors were unable to create new identification setups using the real actuator, it was necessary to develop an identification scheme that relied on a deeper analysis of existing signals. To do so, the fast Fourier transform (FFT) of the output was used. This technique is widely used on signal processing [5] and allows for fast calculation of a signal's spectral decomposition [4].

The initial model created by this technique is described on [9] and reproduced on **Figure 5**.

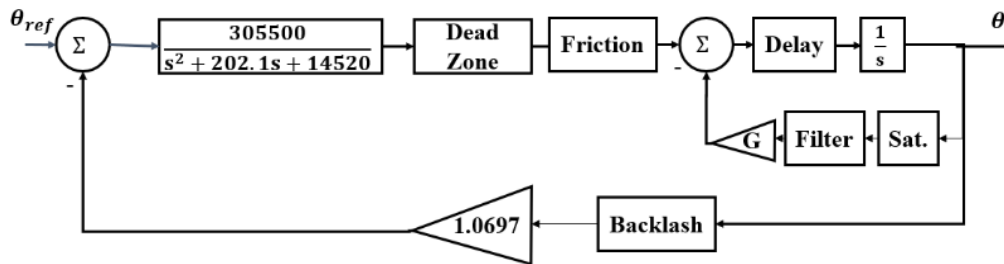

Figure 5: Intermediate actuator model [9].

The original nonlinear elements – dead zone and backlash – are still present. However, new elements were positioned to reproduce the limit cycle seen on tests. The friction block models an offset seen in the opposite direction of the output's derivative, which is mathematically equivalent to a negative Coulomb friction.

Furthermore, a detailed analysis of the FFT for the derivative of the output signal showed that frequencies between 9 Hz and 10 Hz were being excited on the actuator before the integral on the direct path, which motivated the inclusion of a feedback filter set to those frequencies. Figure 6 shows a comparison between the absolute value of the FFT for this signal in the HWIL results and on a simulation with the model on Figure 5.

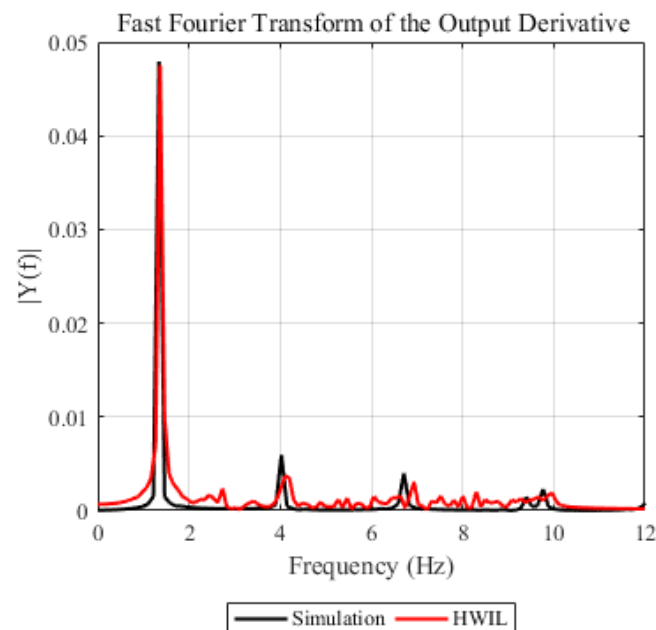

Figure 6. Comparison between the absolute value of FFT for the output derivative on both HWIL results and simulated model.

Finally, the saturation block was included so that the internal feedback loop would not inadvertently create false oscillations when under a non-zero input.

#### 4.1 Limit Cycle Bifurcation

Different initial conditions for the integral block would lead to different limit cycle responses, which is consistent with results seen on the real actuator. This is illustrated by the phase plane on Figure 7.

While the model presented on Figure 5 generated reasonable results for most test cases, a few of the results suggested the existence of a limit cycle bifurcation that could not be reproduced by simply changing the initial conditions on its single integral.

It can be seen, however, that the model has a second order transfer function which hides two other integrals with implicit null initial conditions. When dealing with nonlinear phenomena, however, this hypothesis may be too strong.

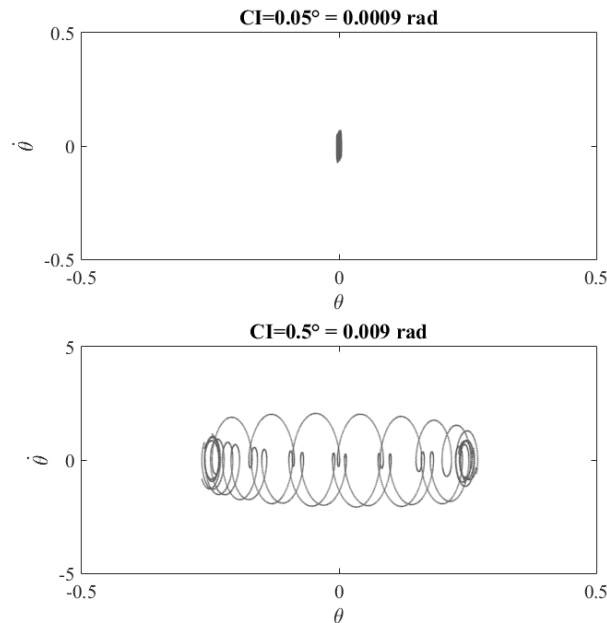

Figure 7: Limit cycle bifurcation with a single initial condition for a given test condition.

Therefore, it is necessary to replace the transfer function in question by a separate structure, as described by Figure 8, in which  $A = K_1/K_2$ ,  $B = K_2$  and  $C = K_3/K_1$ .

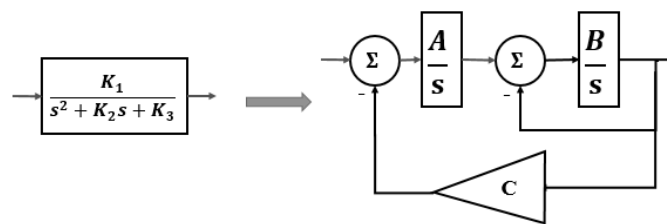

Figure 8: Alternative structure for part of the linear model of the actuator.

#### 4.2 Influence of Transport Delay Positioning

Throughout the entire identification process, the actual positioning of the transport delay block was uncertain.

If an analogy is made with the mathematical model presented on section 1, it is reasonable to assume the transfer function in Figure 8 is equivalent to the second order system that modelled the relationship between the electric current and the cylinder position. Therefore, it is possible that the transport delay is best positioned inside that structure, and not near the end of the forward path, as previously imagined.

To test this hypothesis, the phase plane for the output was recreated by taking the output derivative, as seen on Figure 9. This was then compared to simulated phase planes for different transport delay positions, as reproduced on Figure 10.

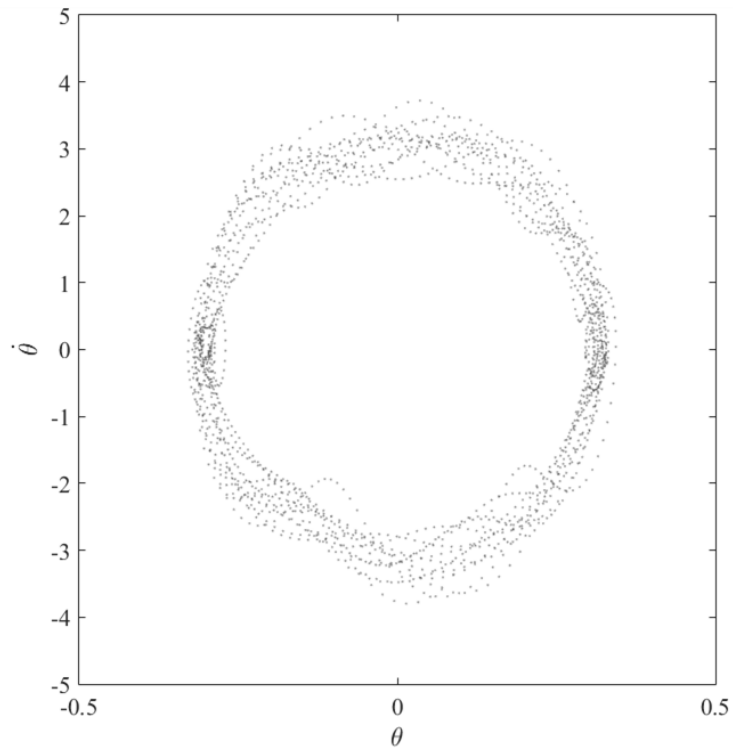

Figure 9: Phase plane created from HWIL output.

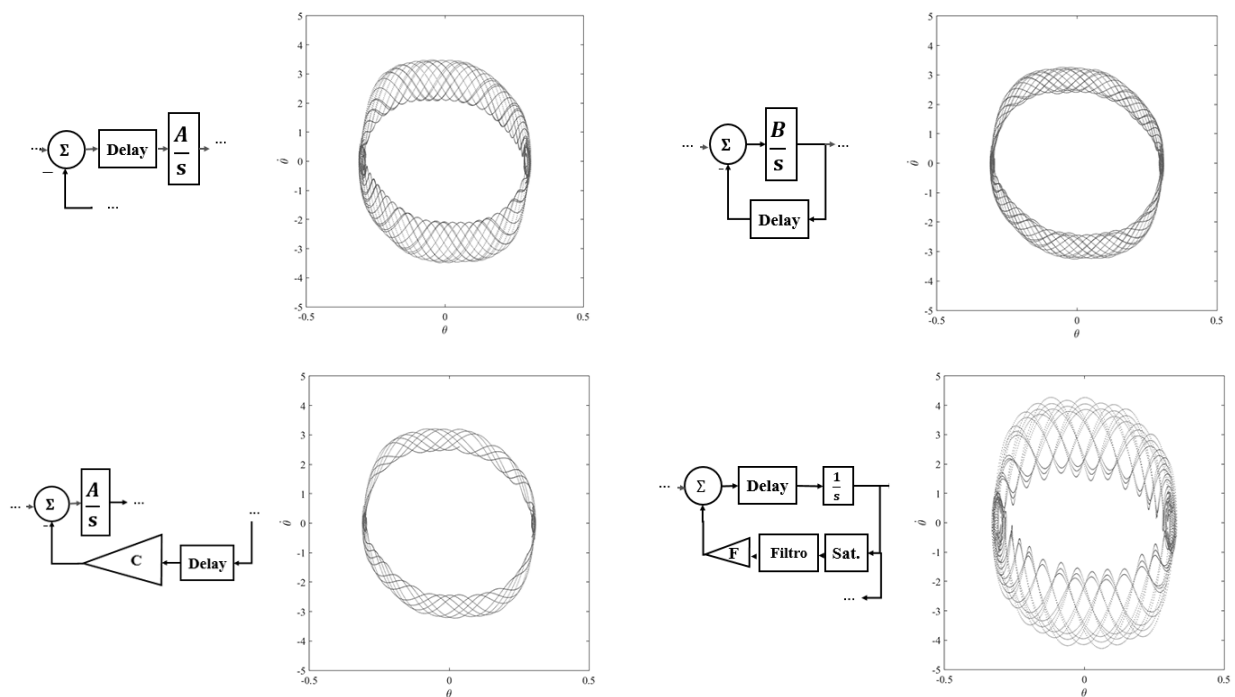

Figure 10: Phase plane comparison of different transport delay positions.

Given the response seen, the first configuration on Figure 10 was chosen, with the transport delay block being positioned before the first integral.

### 4.3 Noise Level

Finally, one must consider the influence of system noise when modeling real systems. When analyzing the data obtained from the studied electrohydraulic actuator, it was possible to observe that a small noise with approximately constant absolute value throughout the entire frequency spectrum considered, as seen on Figure 11.

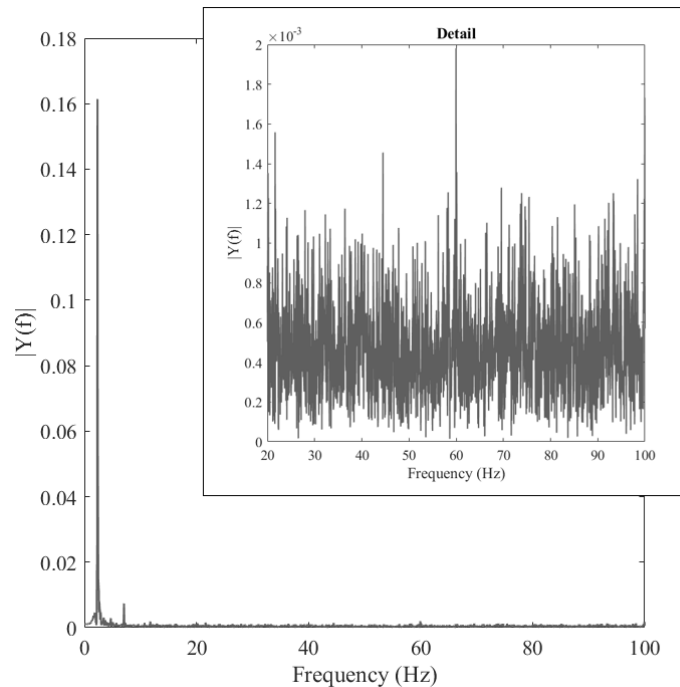

Figure 11: FFT analysis for actuator output data. Overlapped image shows zoomed in detail between 20 Hz and 100 Hz.

Therefore, this was modeled as a band-limited white noise block added to the actuator output, with noise power chosen to match the real data.

## 5. Final Model

The final model proposed can be seen on Figure 12. The relevant parameters are described on Table 1.

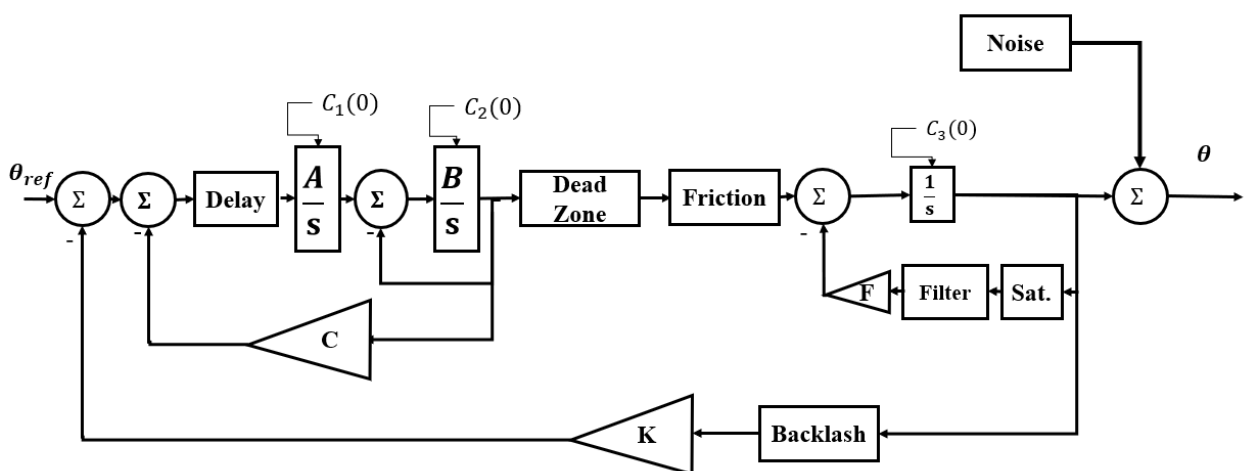

Figure 12: Nonlinear model for an electrohydraulic actuator

Parameter	Value
Dead Zone	0.0083
Backlash	1.1625e-04
Transport Delay	0.0017
Friction Offset	-0.0054
Saturation	0.01
Gain A	15116
Gain B	202.1
Gain C	0.0475
Gain F	72
Gain K	1.0697

Despite how this model was developed using a separate empirical approach, some similarities can be raised when comparing the final configuration to the mathematical model seen on Figure 2.

More specifically, both models have a second order linear model on the forward path while on the internal feedback loop, both models have an improper second order filter, which is consistent with a low pass filter.

Figure 13 shows how the proposed model compares to actual HWIL simulation results. The limit cycle generated by the simulation is extremely similar to the experimental results in shape, amplitude and phase.

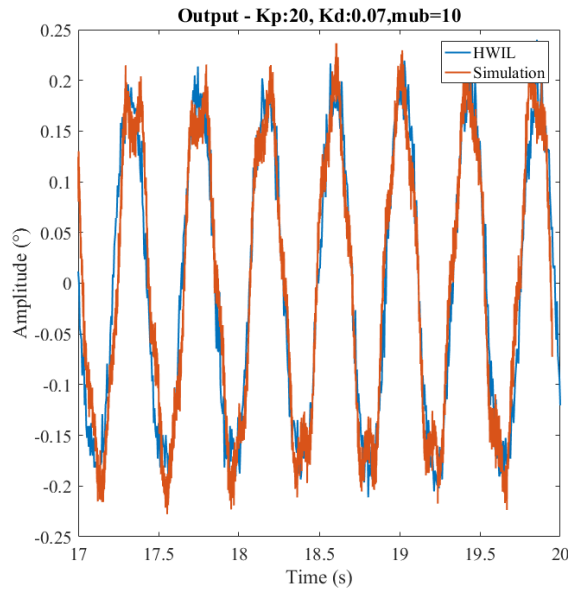

Figure 13: Limit cycle comparison for initial conditions  $C_1 = 0.1$ ,  $C_2 = 0.1$  and  $C_3 = 0.0052$ .

The proposed model is also able to reproduce open loop results. Figure 14 shows how it responds to a step input when compared to the real actuator and Figure 15 shows its response under a sinusoidal input. In both cases, the model is able to reasonably mimic the real system's behavior in phase and amplitude.



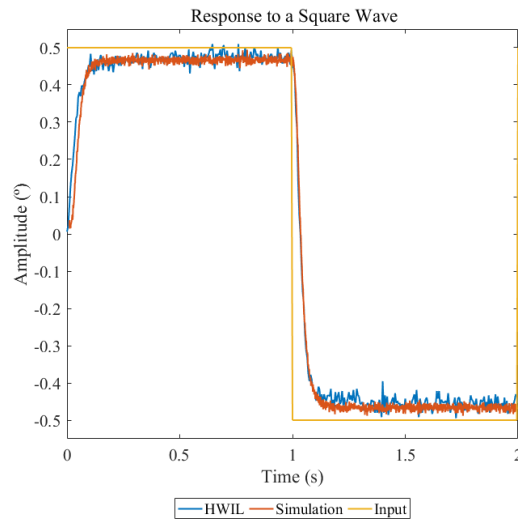

Figure 14. Open loop comparison for a step input.

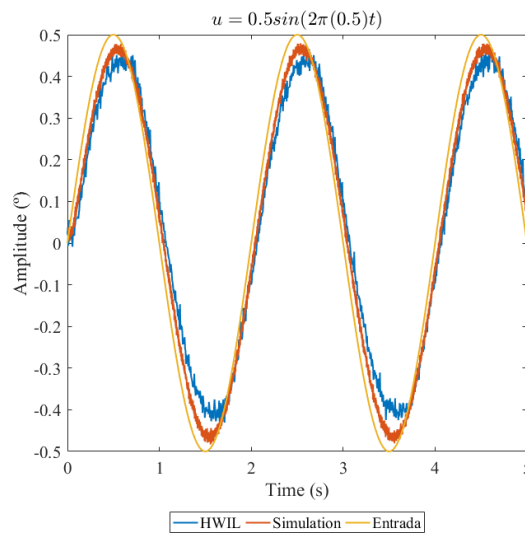

Figure 15. Open loop comparison for a sinusoidal input.

The noise power was adjusted in order to fit each setup.

## 6. Conclusion

This work presented a new modelling strategy for nonlinear actuators used for thrust vector control on the Brazilian Satellite Launcher VLS.

While it is possible to design experiments from which system identification can be gathered, sometimes the necessary resources are not available. Therefore, this paper shows how it is possible to construct a reasonably complex model using only inference-based analysis and already acquired results.

Starting from an initial model based on first harmonic analysis, this work presented a framework from which was possible to derive a reasonable configuration based on existing data. The resulting model not only reproduced the observed behavior of the electrohydraulic actuator studied but also showed consistency with the nonlinear mathematical model of the system by including a previously unused feedback term.

Furthermore, it was possible to identify the influence of the initial conditions of the system and how it could not be simplified by a transfer function. This shows how it is not always prudent to compare real data with transfer functions models, since initial conditions can alter the system behavior, especially when considering nonlinear configurations. Therefore, it was possible to reproduce the bifurcation of the limit cycle and recreate results seen on the real actuator

studied. The influence of the transport delay position was also considered, and it was seen that its position can affect the phase plane diagram and influence the identification process.

Finally, the influence of noise in limit cycle analysis was considered. It is possible to observe how very small noise levels influence the limit cycle seen on closed loop analysis, which may influence identification results.

## References

- [1] Avila, M. A., Loukianov, A. G., Sanchez, E. N. 2004. Electro-hydraulic actuator trajectory tracking. In: American Control Conference. 3:2603 - 2608.
- [2] Bueno, A. M. 2004. Projeto de sistema de controle com não-linearidade causadora de ciclo-limite. Master Thesis. INPE.
- [3] Chu, E. 2008. Discrete and Continuous Fourier Transforms: Analysis, Applications and Fast Algorithms. CRC Press.
- [4] Duhamel, P., Vetterli, M.. 1990. Fast Fourier Transforms: a tutorial review and state of the art. Signal Processing. 19:4:259-299.
- [5] He, S., Sepehri, N. 1999. Modeling and prediction of hydraulic servo actuators with neural networks. In: American Control Conference. 5:3708 – 3712.
- [6] Hahn, P. 1994. Input/output linearization control of an electro servo actuator. In: IEEE Conference on Control Applications.
- [7] Leite Filho, W. C., Bueno, A. M. 2003. Analysis of limit-cycle phenomenon caused by actuator's nonlinearity. In: 12th IASTED International Conference on Applied Simulation & Modeling. 484-489.
- [8] Leite Filho, W. C., Carrijo, D. 1996. Hardware-in-the-loop simulation of Brazilian Launcher VLS. In: 3rd International Conference on Spacecraft Guidance, Navigation and Control Systems. 355-358.
- [9] Leite Filho, W. C., Guimaraes, J. 2016. Identification scheme for the nonlinear model of an electro-hydraulic actuator. In: 9th EUROSIM Congress on Modelling and Simulation.
- [10] Merritt, H. E. 1967. Hydraulic Control Systems. Wiley.
- [11] Moreira, F. J. O., Leite Filho, W. C. 1988. Identificação de um servomecanismo de uma tubeira movel. In: VII Congresso Brasileiro de Automatica.